

APPROVED
FOR
PICKY &
FUSSY
KIDS OF
ALL AGES

BY
JASON
KIRSCHNER

Mr PARTICULAR

THE WORLD'S CHOOSIEST CHAMPION!



THAT'S
ME!

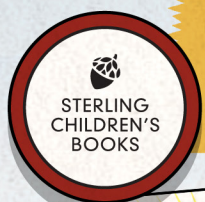

★ ACTIVITY KIT ★



ATOMIC BEAR



DARING DUCK



DR. SLIMYHANDS



KICKIN' CHICKEN

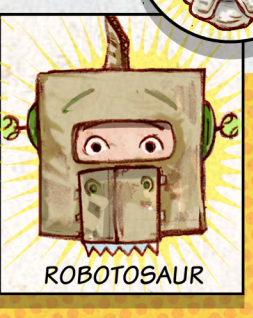

ROBOTOSAUR



THERE'S NO CHOOSIER CHAMPION THAN MR. PARTICULAR: he says **NO** to squishy mud, gross green things, tucked-in shirts, humming, and anything with coconut. But, when his friends in the "Super-Duper Group" finally get fed up with his fussiness, can Mr. Particular prove that even the super-squeamish can save the day?

This fun comic-book-style story will delight even the most fantastically finicky kids!

Inside this packet, you'll find reproducible activity sheets with things to draw, word games to play, and puzzles to solve. Just photocopy the pages, gather some crayons and pencils, and have a fabulous event!

CONTENTS OF THE KIT INCLUDE:

- Spot the Differences
- Writing Activity: Are You a Mr. Particular, Too?
- A Most Particular Maze
- Word Search
- Writing Activity: What Kind of Superhero Would You Like to Be?
- Crossword Puzzle
- Connect the Dots
- Trading Card Cut-Outs
- Answer Key



"I ENJOYED MR. PARTICULAR AND SO WILL YOU. THIS IS A GREAT BOOK FOR KIDS—A TERRIFIC STORY, BEAUTIFULLY ILLUSTRATED." —DAVID LETTERMAN

SPOT THE DIFFERENCES

These two pictures are *ALMOST* alike . . . but not quite! Can you spot the 7 differences and circle them?

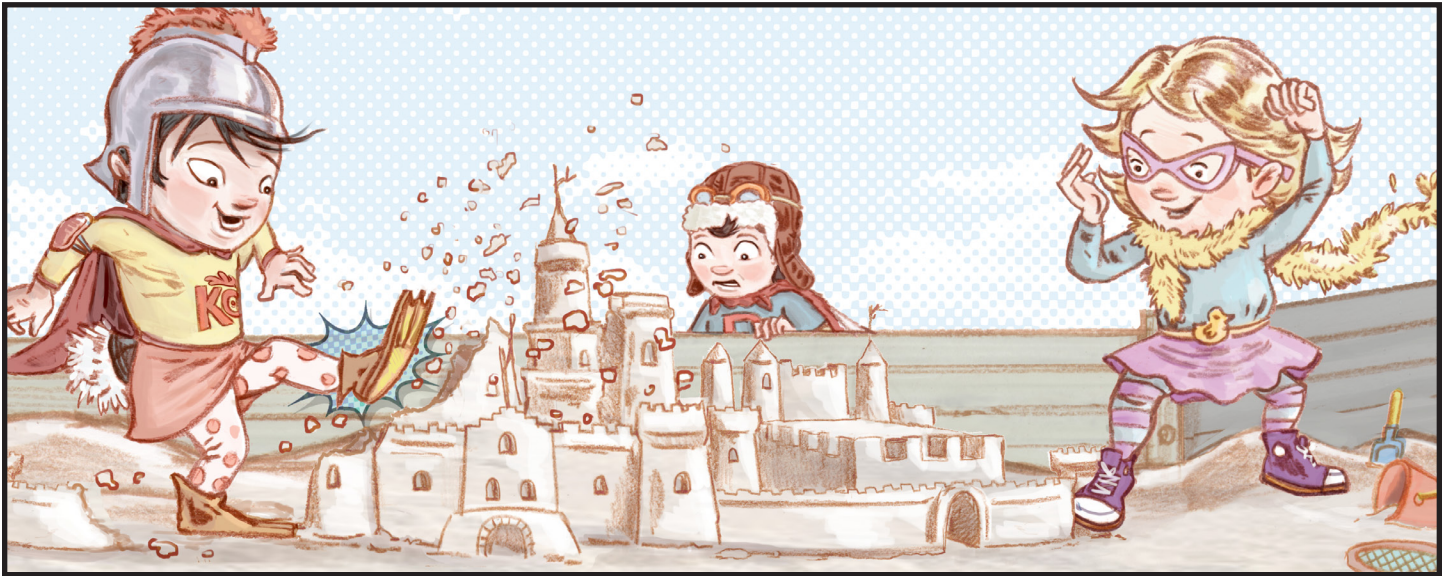



ARE YOU A MR. PARTICULAR, TOO?

There are so many things Mr. Particular doesn't like! Are you just like him? What makes you say "**EWWWW! NO WAY!**" Write it down here and then draw a picture.





A MOST PARTICULAR MAZE

ICKY, SLICKY MUD! Can you help Mr. Particular save Atomic Bear without having to step in it?





WORD SEARCH

Find these words from the book in the word search below. Do you remember them from the story?

Search the grid horizontally, vertically, and diagonally to find the hidden words. (Letters may be used more than once.)

| | | | | | | | | | | | |
|---|---|---|---|---|---|---|---|---|---|---|---|
| C | E | E | W | P | U | M | B | D | H | P | O |
| O | B | S | F | A | C | E | D | E | I | O | S |
| C | G | F | O | R | C | R | A | C | E | D | P |
| O | C | R | R | T | E | U | P | W | U | S | I |
| N | H | I | T | I | D | S | O | Q | T | T | C |
| U | E | E | R | C | C | H | O | O | S | Y | K |
| T | E | N | E | U | S | Q | U | I | S | H | Y |
| S | R | D | S | L | K | E | T | C | H | U | P |
| U | I | S | S | A | H | I | M | U | D | N | F |
| P | N | E | A | R | H | E | R | O | W | O | U |
| E | G | A | C | H | A | M | P | I | O | N | S |
| R | H | U | M | M | I | N | G | O | T | N | S |



WORD LIST

| | | | |
|------------|---------|---------|----------|
| Particular | Squishy | Mud | Coconut |
| Ketchup | Hero | Choosy | Champion |
| Cheering | Friends | Raced | Fortress |
| Picky | Super | Humming | Bees |
| Fuss | | | |



WHAT KIND OF SUPERHERO WOULD YOU LIKE TO BE?

Mr. Particular was named Mr. Particular because he is very...well... particular. What makes you unique? What kind of hero represents you?

IF I WERE A SUPERHERO, I WOULD...

• HAVE THIS SUPER NAME _____

• HAVE THIS SPECIAL SUPERPOWER _____

• RESCUE _____

• BE AS STRONG AS: _____

• ALWAYS EAT _____ FOR DINNER

• WEAR THIS COSTUME _____



DRESS THE SUPERHEROES!

Pick a hero from this page, color, and cut out your favorite accessories or draw some of your own. Assemble with tape or glue.
BOOM! INSTANT HERO!

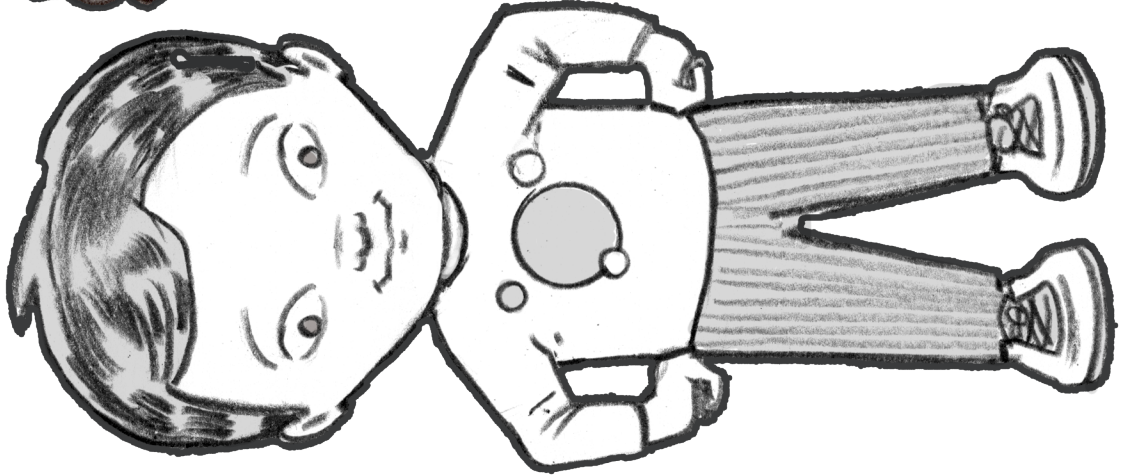
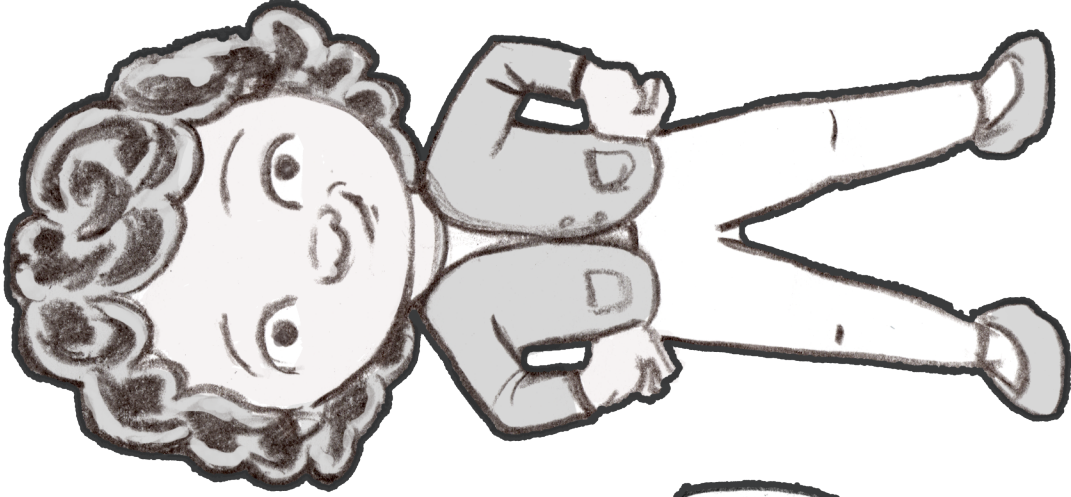
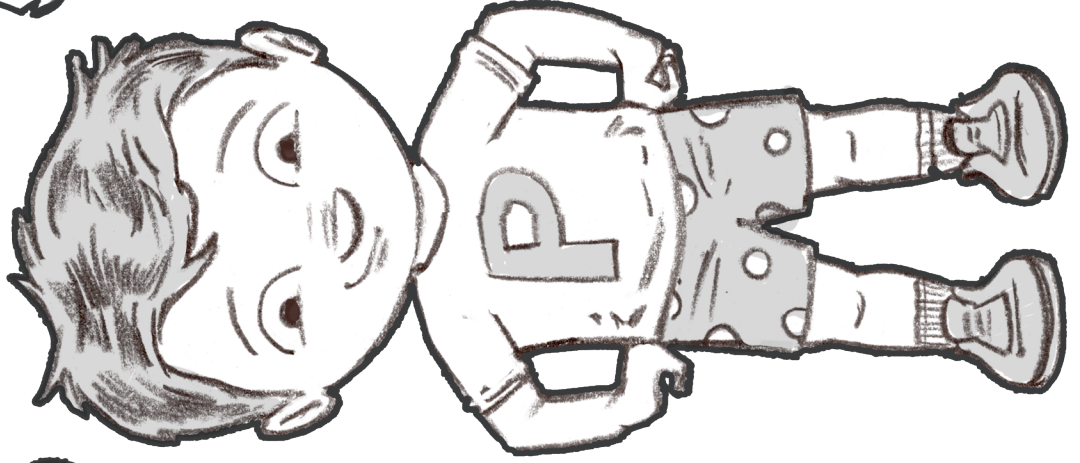
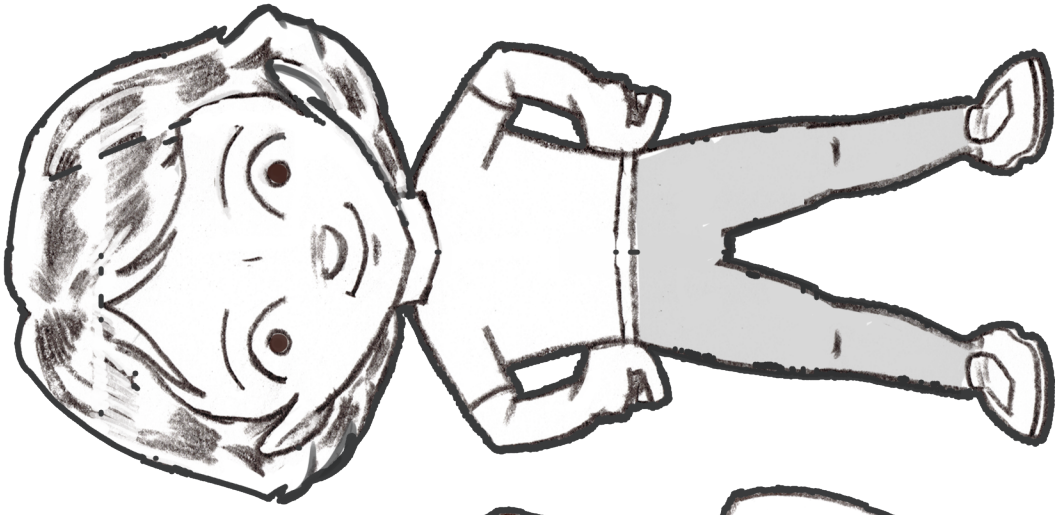

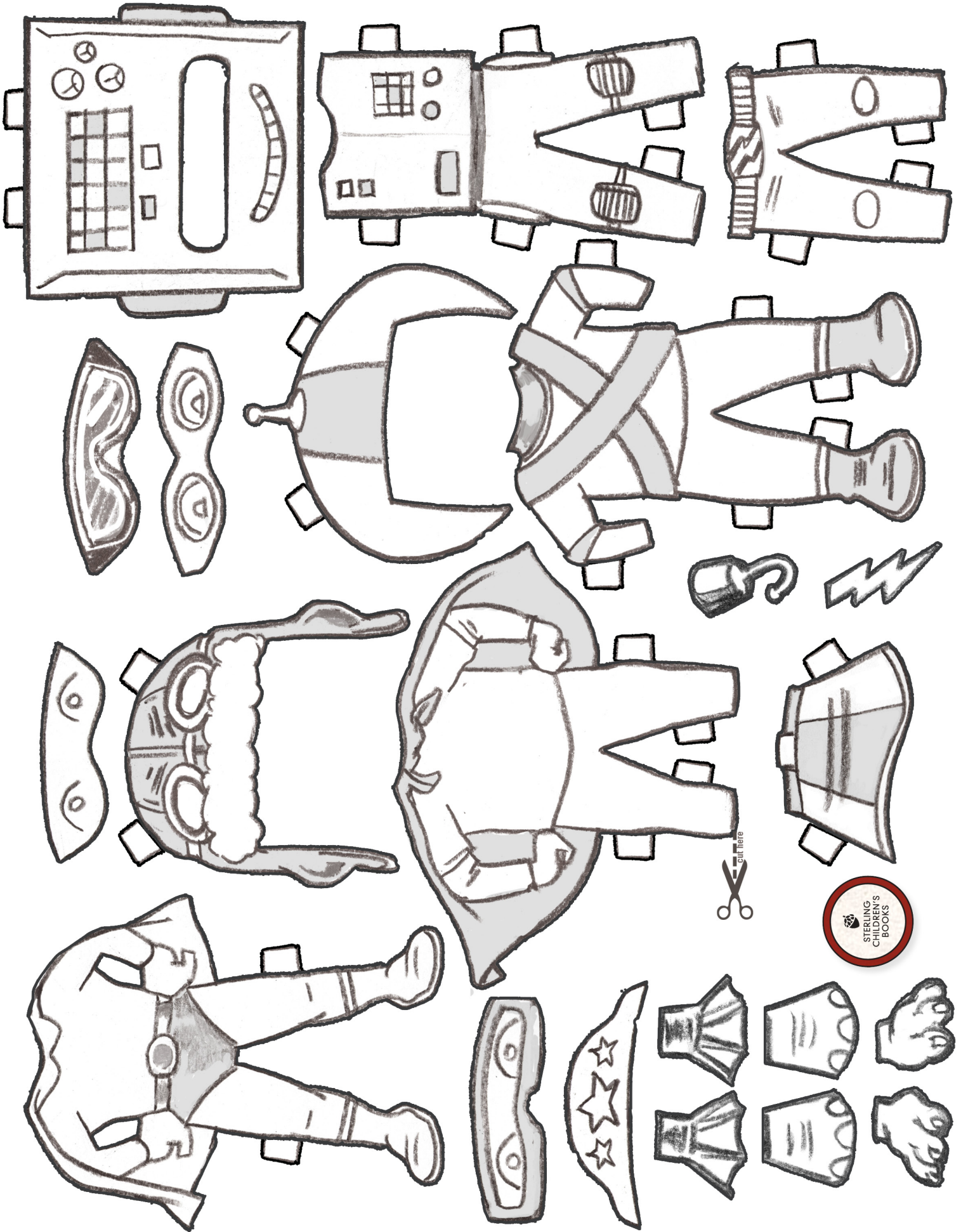

CROSSWORD

Read the clues below and fill in the spaces of the crossword. Look back through the story and use the word bank if you get stuck!

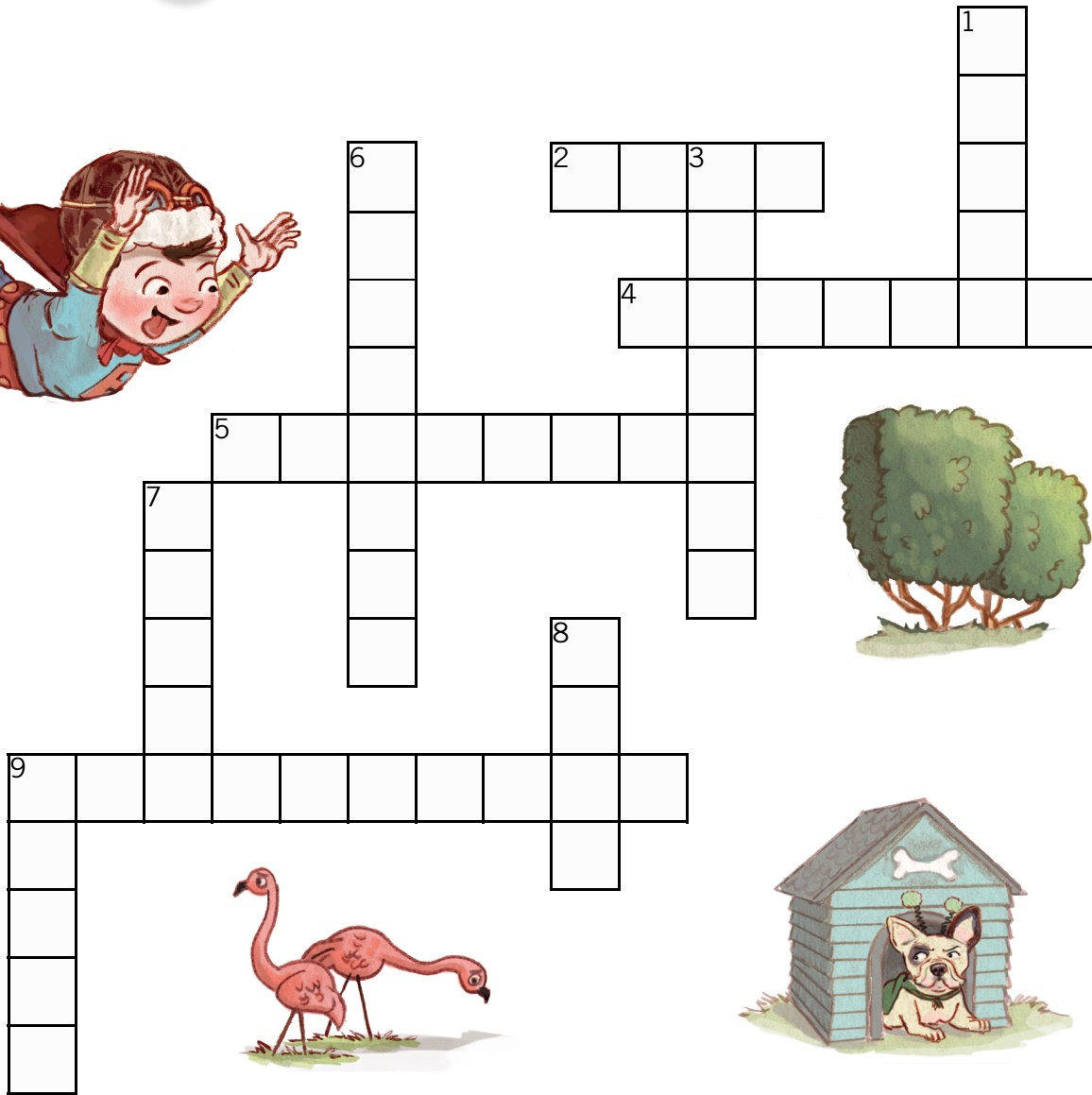

ACROSS

- 2. Fortress of ____.
- 4. I'm not _____, I'm roaring!
- 5. Nothing should ever smell like _____.
- 9. Mr. _____.

DOWN

- 1. ____ is the ickiest color.
- 3. Mud is far too _____.
- 6. Faster than a _____ at the zoo.
- 7. The Super ____ Group.
- 8. Atomic _____.
- 9. You're so ____!

WORD BANK

| | | | | |
|------------|-------|----------|---------|-----------|
| Particular | Bear | Fuss | Squishy | Duper |
| Picky | Green | Coconuts | Humming | Choo-choo |



CONNECT THE DOTS

Connect the dots. What do you see?

START HERE!

35 1 2
34 3
33 4
32 5
31 6
30 7
29 8
28 9
27 10
26 11
25 12
24 13
23 14
22 15
21 16
20 19 18 17

TRADING CARDS

Here are some cool trading cards! Cut them out and share them with friends.



Mr. Particular
★ SUPER-DUPER GROUP ★

SUPER-STATS AGE: 6 ½

HAIR COLOR: BROWN
SUPERPOWERS: Ketchup Kwinkness, Perfect Punctuality, Pretty Picky

SUPER-DUPER SCOOP

Mr. Particular got his bomber hat as a gift for his 4th birthday.



Daring Duck
★ SUPER-DUPER GROUP ★

SUPER-STATS AGE: 6 ¾

HAIR COLOR: Blond
SUPERPOWERS: Quick Quack, Water Resistant, Highly Opinionated

SUPER-DUPER SCOOP

Daring Duck chose her name after feeding a brood of ducklings at the park and deciding that they were "soooo cute."

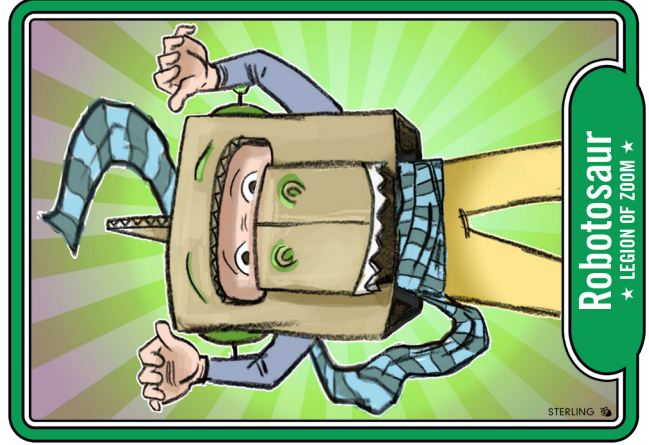

Robotosaur
★ LEGION OF ZOOM ★

SUPER-STATS AGE: 5 ¾
CLASSIFIED

HAIR COLOR: **CLASSIFIED**
SUPERPOWERS: Half Robot/Half Dinosaur, Cardboard Craftiness

SUPER-DUPER SCOOP

Robotosaur's cardboard box was originally used to move his toys to his new house.



Kickin' Chicken
★ LEGION OF ZOOM ★

SUPER-STATS AGE: 6 ¼

HAIR COLOR: Black
SUPERPOWERS: Fowl Flying Kick, Chicken Chop, Cock-a-Doodle-Fu

SUPER-DUPER SCOOP

Coincidentally, KC's favorite meal is fried chicken.

(CUT on solid lines and FOLD on dashed lines.)

FOLD



FOLD

FOLD



FOLD



Mr. PARTICULAR

Lizardbreath
★ LEGION OF ZOOM ★

SUPER-STATS AGE: 2 (14 IN DOG YEARS)

HAIR COLOR: White with Black Spots
SUPERPOWERS: Terrible Lizard Breath, Titanic Tail Wag, Will Eat Anything

SUPER-DUPER SCOOP

The only thing Lizardbreath likes about his pom-pom headband is the chewiness of the pom-poms.



Mr. PARTICULAR

Dr. Slimyhands
★ LEGION OF ZOOM ★

SUPER-STATS AGE: 6½

HAIR COLOR: Black
SUPERPOWERS: Slimy Splash, Green Goo Gobs

SUPER-DUPER SCOOP

The lab coat that Dr. Slimyhands wears used to belong to her mother, who is also a doctor—but less slimy.



Mr. PARTICULAR

Super Pooper
★ LEGION OF ZOOM ★

SUPER-STATS AGE: 1½

HAIR COLOR: Brown
SUPERPOWERS: Super Stinky Poop, Terror Tantrums, Catastrophe Crawl

SUPER-DUPER SCOOP

Even though he throws evil Terror Tantrums, Super Pooper's greatest wish is to be a hero like his brother, Mr. Particular.

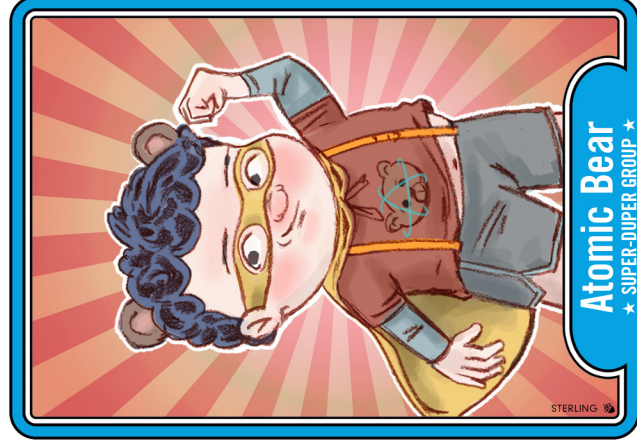

Mr. PARTICULAR

Atomic Bear
★ SUPER-DUPER GROUP ★

SUPER-STATS AGE: 6

HAIR COLOR: Black
SUPERPOWERS: Atomic Roar, Bear Barrage, Fierce Loyalty

SUPER-DUPER SCOOP

Atomic Bear has two sets of bear slippers—one for indoors and one for outdoors, because his mother won't let him wear dirty bear feet in the house.

FOLD



FOLD

(CUT on solid lines and FOLD on dashed lines.)

SPOT THE DIFFERENCES

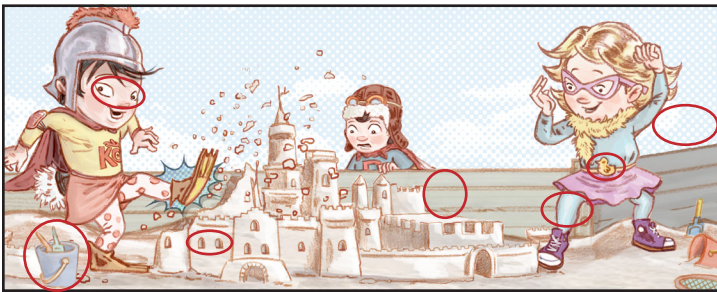

A MOST PARTICULAR MAZE

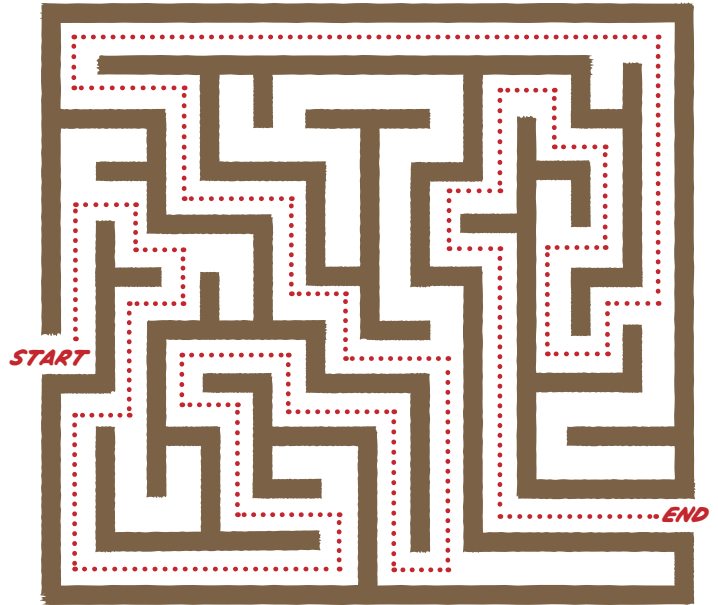

CROSSWORD

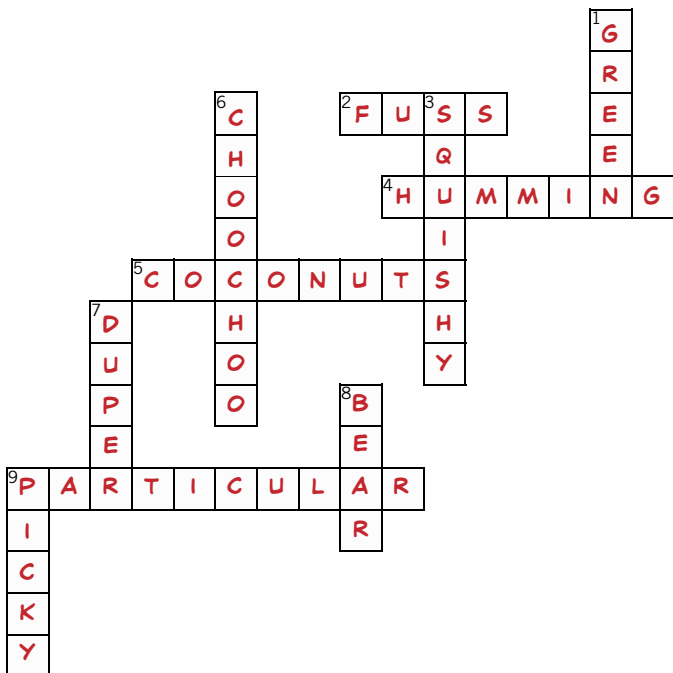

WORD SEARCH

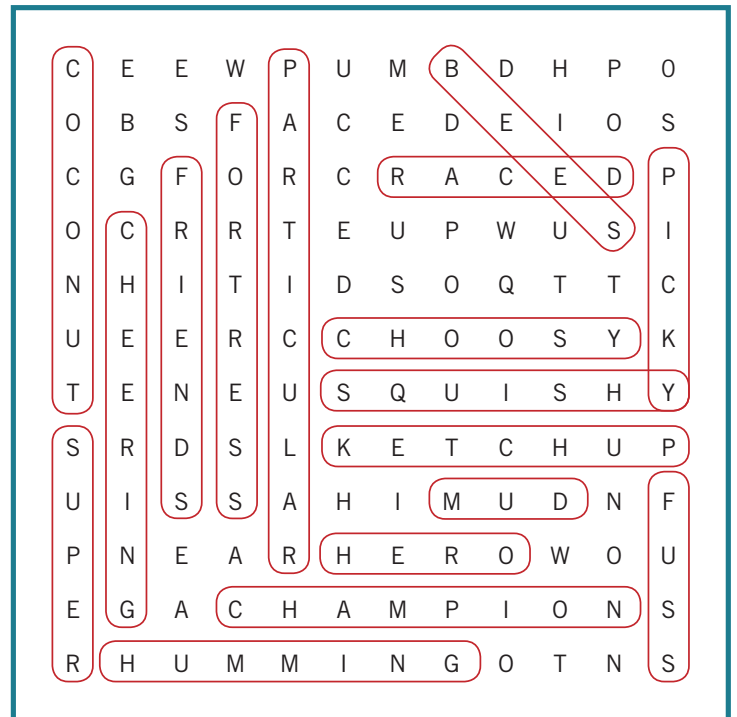

HAVE FUN WITH SOME OF THESE SUPER ITEMS!!!

AVIATION HELMET



Remember Amelia Earhart or Charles Lindbergh? No? Oh, well, they wore hats like this!

No. 4

MARTIAN HEADBAND



Wear this super-springy alien headband while you invade and conquer Earth for your spacey species! NOT FOR DOGS.

No. 96

MYSTERY VILLAIN PACKAGE



Do you feel like being evil, but you're not sure how? This malevolent mystery mixed bag comes with a spiteful super-villain identity, a corrupt costume, and a warped weapon. Cue evil laugh here!

No. 96

TEENY-WEENY CAMERA



The best way to take teeny-weeny, itsy-bitsy spy photos.

No. 331

SUPER SUSPENDERS



When you see how well these things hold up your superpants, you'll have to suspend your disbelief!

No. 194

GLADIATOR HELMET



Conquer like a Roman or enter construction sites with no fear.

No. 57

DOUBLE DECODER WATCH*



Decrypt and decipher double the disastrous dilemmas. Also a compass! (*Does not tell time.)

No. 61

RECORDER WATCH*



Ruffle and rattle your enemies by recoding the codes you just decoded on your Double Decoder Watch. Wear one on each wrist.

(*Also does not tell time. Buy a clock.)

No. 62

BOX-O-SLIME



It's so easy to slime your enemies... and friends. Just add water for instant SLIME!

No. 433

STOUTHEARTED SPYGLASS



Want to fight evil, but can't find any? Either give up—or extend your scope with this intrepid instrument.

No. 102



HERO DOCTOR KIT

Even heroes get hurt. Fix 'em up instantly! Bandages NOT included.

No. 207

MAGNIFYING GLASS*



Great for clue hunting or for looking at the itsy-bitsy pics from the Teeny Weeny Camera. (*Not real glass.)

No. 187

HAWKIE WALKIE-TALKIES



These super-communicators help bird-themed heroes chat with their sidekicks and let bird-themed villains yell at their lackeys. Works up to a distance of 11 feet!

No. 216

FAUX YO-YO



This toy doesn't do anything a real yo-yo can, but from far away it looks real! Enjoy!

No. 008

NON-TRICK SOAP

No trick soap here! Heroes need to clean up after playing in the mud, and this soap will get you **sparkly** and **germ-free**.

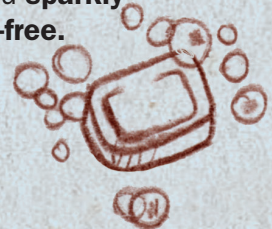

No. 184

ZING RING*



Lots of heroes wear power rings! Then again, so do lots of moms. But their rings aren't power rings like the Zing Ring! ZING!

(*Ring does not power anything.)

No. 241

STEEL MARBLES

REAL STAINLESS STEEL!

Great for games or heroic inventions. Please—whatever you do—don't lose your marbles.

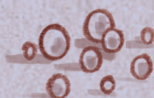

No. 222

FIVE-HERO TENT

Fit up to five heroes in this tent for a stupendous, super-ific sleepover. It's roomy and spacious and doubles as a super headquarters.



No. 215